

40" Full HD Digital LED TV

Installation & Operating Instructions - Please keep for future reference

183/5700

BUSH

Real Life Technology

BMK40



Important - Please read these instructions fully before installing or operating

These instructions contain important information which will help you get the best from your television and ensure safe and correct installation and operation.

For any help concerning set up and use of your TV please call the
Customer Helpline: 0845 604 0105

Lines open: 9am - 8pm Monday to Saturday and 10am - 4pm Sunday

Safety Information	4
Safety Instructions	5
Help & Support	6
Features	7
<i>TV Features</i>	7
<i>Accessories Supplied</i>	7
Remote Control	8
Getting Started	9
<i>Using the remote control</i>	9
<i>Battery fitting</i>	9
<i>TV control buttons</i>	10
<i>Inputs & Outputs</i>	10
<i>Connection types</i>	11
<i>Switching on for the first time</i>	12
<i>First Time Setup</i>	12
Basic Features	14
<i>Menu operations</i>	14
<i>Picture Menu</i>	14
<i>Sound Menu</i>	14
<i>Channel Menu</i>	15
<i>Lock System Menu</i>	17
<i>Setup Menu</i>	18
Advanced Features	20
<i>Electronic Programme Guide (EPG)</i>	20
<i>Digital Teletext</i>	20
<i>Digital Radio</i>	21
<i>Common Interface (CI)</i>	21
<i>Channel List</i>	21
<i>Favorite List</i>	21
<i>On-Screen Displays</i>	22
<i>Connecting to a PC</i>	22
<i>Changing input source</i>	22
Product Support	23
<i>Fitting the base stand</i>	23
<i>Wall Mounting</i>	23
Troubleshooting	24
Specifications	25
Guarantee	26
Help & Support	27

Safety Information

IMPORTANT - Please read these instructions fully before installing or operating



CAUTION
RISK OF ELECTRIC SHOCK
DO NOT OPEN



**TO AVOID THE RISK OF ELECTRIC SHOCK
DO NOT REMOVE COVER OR BACK
NO USER-SERVICEABLE PARTS INSIDE
REFER SERVICING TO QUALIFIED PERSONNEL**



The lightning flash with arrowhead symbol, within an equilateral triangle, is intended to alert the user to the presence of uninsulated dangerous voltage within the product's enclosure that may be of sufficient magnitude to constitute a risk of electric shock to the persons.



The exclamation point within an equilateral triangle is intended to alert the user to the presence of important operating and maintenance (servicing) instructions in the literature accompanying the appliance.



Correct disposal of this Product

Waste Electrical & Electronic Equipment (WEEE)

The crossed out wheeled bin is intended to show that this appliance must not be placed with ordinary household waste at the end of its useful life. To prevent possible harm to the environment or human health from uncontrolled waste disposal, please keep separate from other household waste and recycle it responsibly to promote the sustainable reuse of material resources.

Household users should contact either the retailer where you purchased the product, or their local government office for details of where and how you can take this item for environmentally safe recycling.

Business users should contact their supplier and check the terms and conditions of the purchase contract. This product must not be mixed with other commercial wastes for disposal



Do not place used batteries in domestic waste.

You may return batteries to any Argos store for safe disposal.



CAUTION: Danger of explosion if battery is incorrectly replaced. Replace only with the same or equivalent type. Do not mix old and new or different types of battery. If the product is not to be used for a prolonged time remove the batteries as electrolyte leakage will damage the product and will invalidate the warranty



This is a double-insulated Class II appliance and must not be earthed.



This appliance complies with European Safety & Electrical Directives

Fitting a replacement plug

Should it become necessary to replace the mains plug please follow this diagram.

The BROWN wire must be connected to the LIVE (L) terminal.
The BLUE wire must be connected to the NEUTRAL (N) terminal.

Always replace the fuse with a **5 AMP** BS fuse

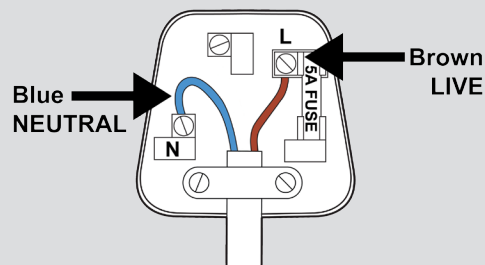

Safety Instructions

IMPORTANT - Please read these instructions fully before installing or operating



Unpacking and handling

Open the carton carefully and remove the polystyrene packing. Carefully lift the TV out and place onto a firm stable surface. Lift off the poly bag and retain all packaging for future use. Keep all packaging away from small children and animals. Remove Energy Efficiency label from the screen, this should peel easily, do not use any tool to remove this label.



Base fitting

This TV is supplied with a separate base to reduce packaging. See Page 23 for fitting instructions and wall mounting.



Positioning your TV

The TV should be placed on a firm table or shelf. If placing in a cabinet ensure there is sufficient spacing for air flow: 10cm above and 20cm at each side.



Ventilation slots

Do not allow objects to be dropped inside the ventilation slots, this could cause a short circuit and a possible fire. Do not allow chains to be dangled into the TV, a serious electrical shock may occur.



Ventilation and heat sources

Do not place material over the ventilation slots, this will cause the TV to overheat and fail. Do not place the TV in direct sunlight or near heat sources such as radiators or fires.



Connections

When connecting the TV to external sources and the mains supply do not place wires that can be tripped over. Do not trap or place heavy objects on the mains cable.



Candles and open flames

Do not place lighted candles (such as tealights) on the top or at the sides of the TV, or any other naked flame near the TV cabinet.



Disconnection device

Where the mains plug or appliance connector is used as the disconnection device, the disconnection device shall remain operable and must be accessible at all times. To be completely disconnected from the mains supply, the mains plug must be removed from the socket completely.



Moisture

Do not place the TV in wet or damp conditions, such as steamy kitchens, basements or other damp places. Do not allow water or other fluids to enter the TV. Do not touch the mains plug with wet hands. Should moisture enter the TV, disconnect from the supply and call the customer helpline.



Cleaning

Use a soft dry cloth, for stubborn stains use a soft moist cloth with a dilute mild detergent. Do not use alcohol-based fluids or abrasive cleaners or materials.



LCD Screen

Do not hit or cause impact to the LCD screen. The screen consists of many individual pixels and is easily damaged. Bright or dark dots may occur and are not covered by warranty.



Lightning

During a thunderstorm or when leaving the appliance for long periods such as holidays, disconnect the aerial input (if external aerial) and remove the mains plug; this is to prevent power surges damaging the product.



Headphone use

When using headphones do not use for long periods. Loud music can permanently damage your hearing.

Help & Support

The Argos Technical Helpline is here to help

Technical experts are available 7 days a week

- **Simple help and advice on setting up your digital equipment.**
- **Guidance on connecting other devices to your television such as DVD player, Sky, home cinema system or a games console.**
- **Order spare parts, including that lost remote control.**
- **Any other technical issues you may need assistance with.**

Call us today: 0845 604 0105

Local call rate applies*

Lines open 9am-8pm Monday to Saturday and 10am-4pm Sunday.

*Calls to Argos enquiry lines may attract a charge and set up fee from residential lines depending on your call plan/tariff. Mobile and other providers costs may vary, see www.bt.com/pricing for details.

For security and training purposes, telephone calls to and from customer service centres may be recorded and monitored. Calls from Republic of Ireland will attract international call charges.

TV Features

- Full HD Digital LED Television
- Fully integrated Digital Freeview (DVB-T)
- 7-Day Electronic Programme Guide (EPG)
- Now & Next Guide
- 3 x HDMI sockets (with HDCP)
- Stereo 10W Speakers
- SRS TruSurround HD
- Multi-Language On-Screen Display: English, German, French, Italian, Spanish, Dutch, Portuguese
- SCART socket
- Composite Video (CVBS) socket
- Component Video socket
- Digital Teletext
- Digital Subtitles
- Headphone socket (3.5mm)
- Digital and analogue tuners
- Automatic setup & tuning
- Manual tuning
- Sleep timer
- Parental controls

SRS TruSurround HD™ creates an immersive, feature-rich surround sound experience from two speakers, complete with rich bass, high frequency detail and clear dialog.

Accessories Supplied

Installation & Operating Instructions

Quick Start Guide

Remote Control

Stand Stem

Stem Screws (long) x 4

Stand Base

Base Screws (short) x 4

Batteries: AAA x 2

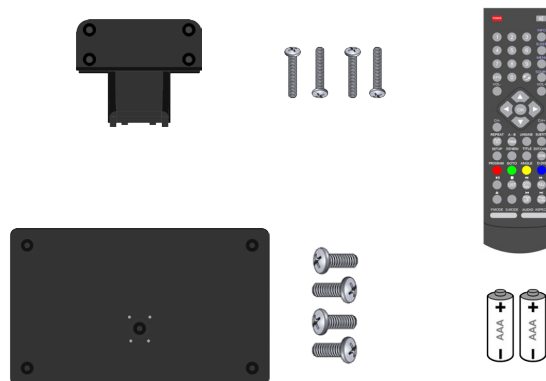

Remote Control

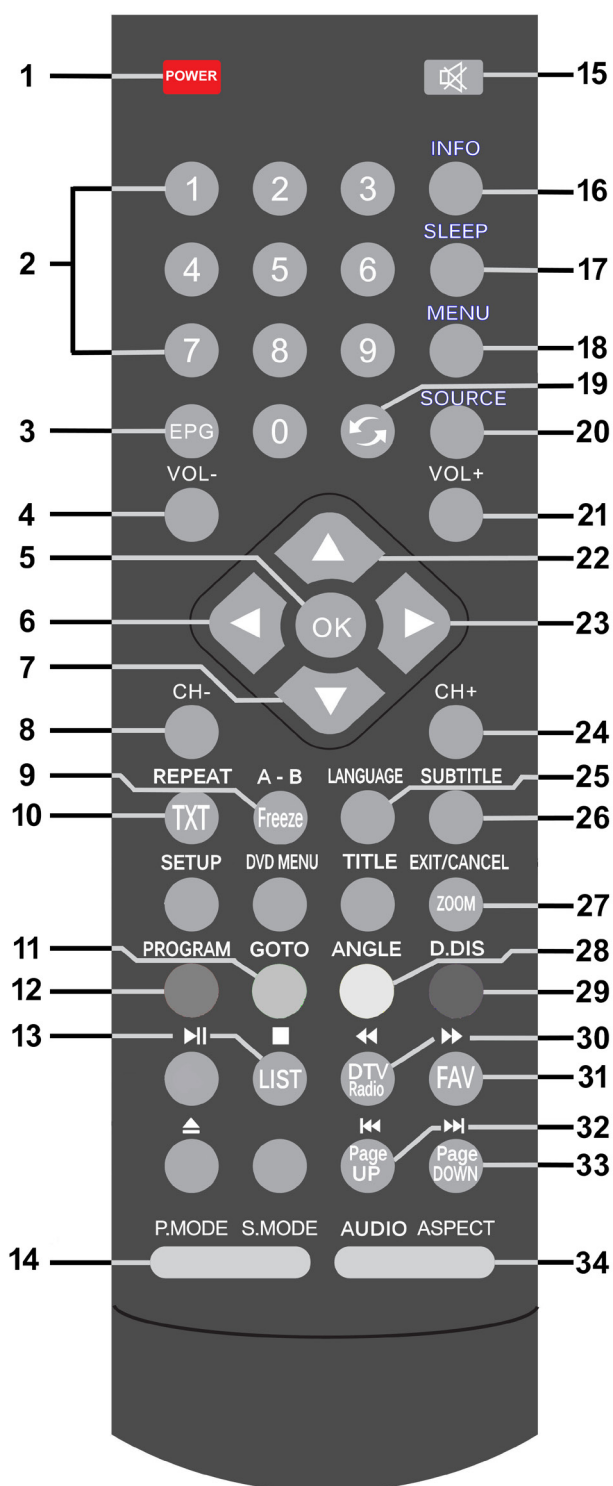

1. **POWER**: Switch TV in and out of standby
2. **0-9 Numeric keys**: Number or channel entry
3. **EPG**: Display Electronic Programme Guide
4. **VOL-**: Decrease volume
5. **OK**: Confirm selection, show channel list
6. **Left arrow**: Navigation
7. **Down arrow**: Navigation
8. **CH-**: Channel down
9. **Freeze**: Freeze picture on screen
10. **TXT**: Display/remove teletext
11. **GREEN**: Option button
12. **RED**: Option button
13. **List**: Display channel list
14. **P Mode / S Mode**: Cycle picture and sound modes
15. **MUTE**: Toggle volume muting
16. **INFO**: Display channel/programme information
17. **SLEEP**: Cycle sleep timer length
18. **MENU**: Display main settings menu
19. **Swap**: Swap to last channel (DTV)
20. **SOURCE**: Select input source
21. **Vol+**: Increase volume
22. **Up arrow**: Navigation
23. **Right arrow**: Navigation
24. **CH+**: Channel up
25. **LANGUAGE**: Cycle language options (DTV)
26. **SUBTITLE**: Display subtitles (DTV)
27. **EXIT/CANCEL**: Exit menu or cancel selection
28. **YELLOW**: Option button
29. **BLUE**: Option button
30. **DTV/Radio**: Toggle TV or radio mode (DTV)
31. **FAV.**: Display favourite list (DTV)
32. **Page Up**: Navigation
33. **Page Down**: Navigation
34. **Audio / Aspect**: Cycle audio mode and picture size settings (audio V.I mode for visually impaired)

Getting Started

Using the remote control

- Point the remote control at the REMOTE SENSOR on the TV
- The recommended operating distance is up to 3 metres (10 feet)
- Bright sunlight shining onto the remote sensor may cause the TV not to respond correctly

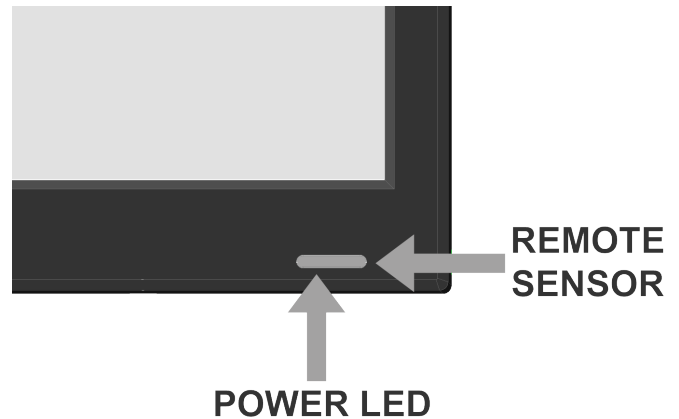

Battery fitting

- Open the battery cover
- Fit 2 x AAA batteries. Ensure the battery polarities are correct (+ to +, - to -)
- Replace the battery cover

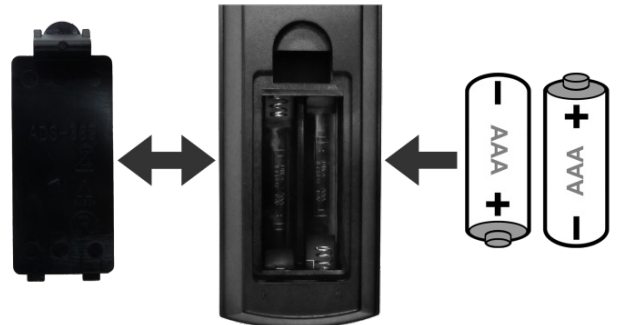

Battery Safety & Disposal

To prevent injury, do not break open or throw exhausted batteries in a fire.

Do not mix batteries, old and new, carbon or alkaline.

Do not use rechargeable batteries.

Remove batteries if not using the remote control for long periods to prevent leakage.

If the batteries do leak, clean the compartment with soapy water and scrape any residue from the contacts.

Do not touch or ingest battery residue.

Should you swallow chemicals leaked from a battery, please urgently consult a medical adviser.



Do not place used batteries in domestic waste
You may return used batteries to any Argos store for safe disposal



Getting Started

TV control buttons



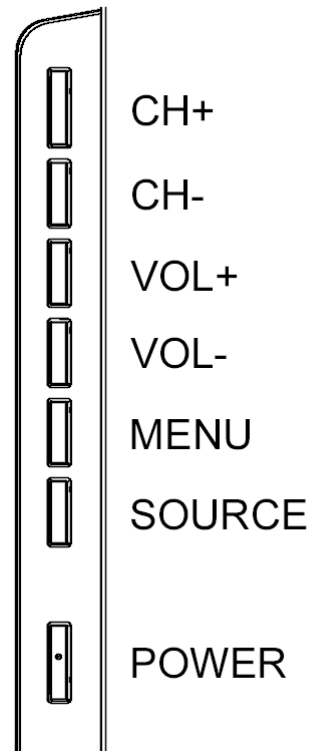



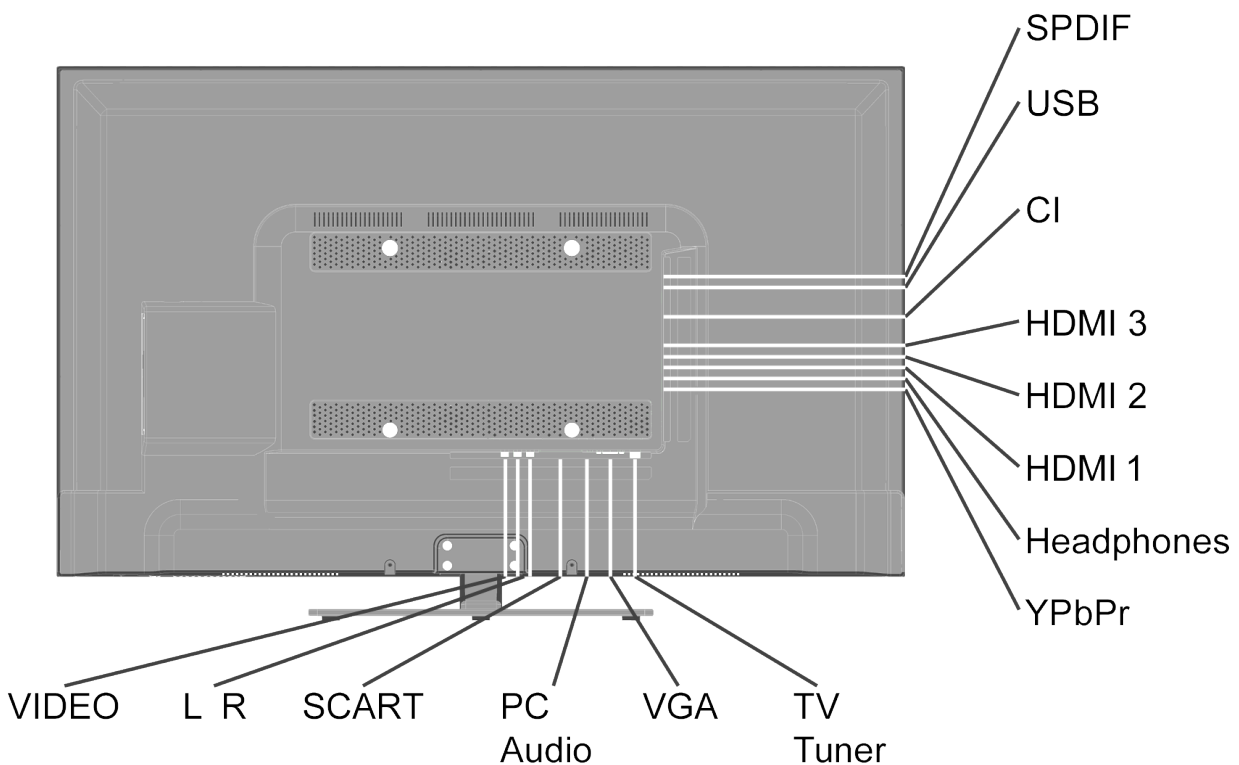



- **CH+**: Increases channel selection by 1 with each press.
- **CH-** : Decreases channel selection by 1 with each press.
- **VOL+**: Increases volume level. In menu mode increases values.
- **VOL-** : Decreases volume level. In menu mode decreases values.
- **MENU**: Select the menu function. If in a sub menu, will revert to previous menu level.
- **SOURCE**: Select input source
- **POWER**: Turn TV on from standby. Also return TV to standby

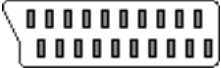

Inputs & Outputs

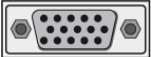

Connection types

Connector	Name	Type	Description	Purpose
	TV Tuner	Input	Aerial (RF) input	Required for receiving Digital Freeview, also used for aerial distribution systems, such as Sky or cable
	HDMI	Input	High Definition (HD) digital video and audio input	Connecting: Blu-ray, games consoles, Sky HD, HD camcorders
	SCART	Input	Standard Definition (SD) video and audio input	Connecting: VCR, DVD players, games consoles, satellite receivers
	YPbPr	Input	Component HD analogue video input	Connecting (video): games consoles, HD camcorders, Blu-ray <i>Additional cable required</i>
	VIDEO (yellow)	Input	Composite SD video input	Connecting (video): games consoles, DVD players, camcorders
	L R (white / red)	Input	Audio input for VIDEO and YPbPr	Connecting (audio): games consoles, DVD players, camcorders
	VGA	Input	PC video input	Connecting (video): personal computers, laptops
	PC AUDIO	Input	PC audio input	Connecting (audio): personal computers, laptops
-	CI	Input	Common Interface	Conditional Access Module (CAM) required for viewing Top Up TV
	Headphones	Output	3.5mm headphones	Connecting: headphones
	SPDIF	Output	PCM Digital Audio	Connecting: digital amplifiers, surround sound systems
-	USB	-	-	Service use only

Getting Started

Switching on for the first time

Once you have mains power and an aerial connected, you are ready to switch your TV on and complete the setup and tuning:

- Press **POWER** button on remote control or TV
- LED on front of TV should turn from RED to GREEN
- Welcome message will be displayed, press **OK** to continue

First Time Setup

OSD Language

Choose on-screen display language

Press ◀▶ to adjust

Press ▼ to continue

Mode Setting

Choose *Home Mode* for normal viewing, choose *Store Mode* for bright environments

Press ◀▶ to adjust

Press ▼ to continue

Country

Press ◀▶ to adjust

Press ▼ to continue

Auto Scan

Choose *DTV* for digital Freeview, choose *ATV* for other systems, such as Sky

Press ◀▶ to adjust

Press ▼ to continue

Start

Press ▶ or **OK** to begin the automatic tuning

POWER

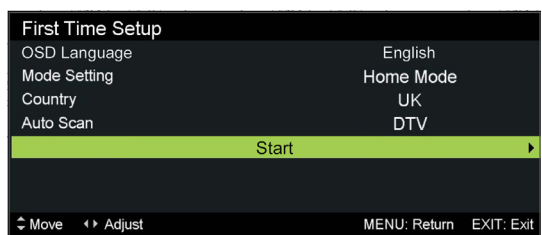
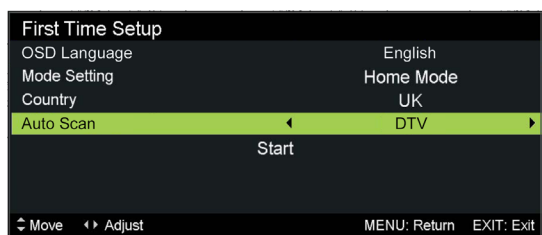
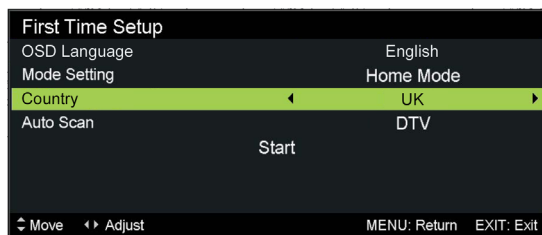
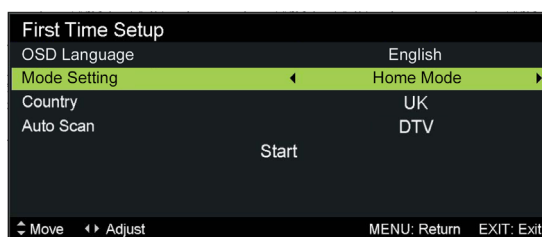
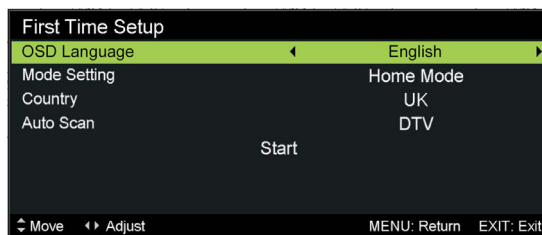

Getting Started

Tuning progress will be shown

As the progress bar moves along any channels found will be indicated.

If you are in a mixed-signal area the region selector screen will be shown.

This allows you to select which local transmitter you would like to tune to.

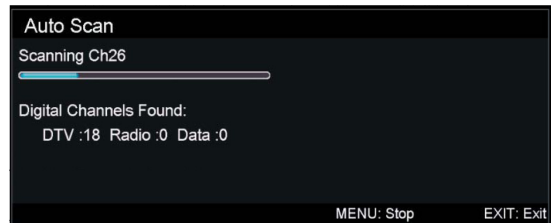

Country Code

- Choose from countries found.
- Press ◀▶ to adjust
- Press ▼ to continue

Primary Region

- Choose from tuning regions found
- Press ◀▶ to adjust
- Press ▼ to continue

Secondary Region

- Choose from main local transmitters found
- Press ◀▶ to adjust
- Press ▼ to continue

Tertiary Region

- Choose from local transmitters found
- Press ◀▶ to adjust
- Press ▼ to continue

Confirm

- Press ▶ or **OK** to complete

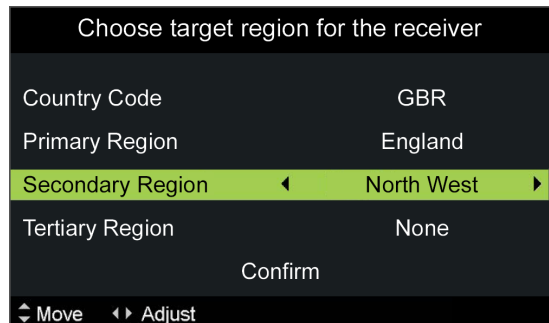

Once tuning has completed the TV will revert to the first channel found.

That's it, you're done!

- No signal?**
- Missing channels?**
- Picture breaking up?**
- Sounds like an aerial issue...**

Digital Freeview requires a fairly strong, high quality aerial signal to work fully: a professionally installed outdoor aerial system is recommended. An indicator of an inadequate aerial signal is the picture and/or sound breaking up, channels missing, or no channels found at all. If tuning to a satellite system, such as Sky, remember to choose ATV as the Auto Scan type.

Basic Features

Menu operations

All settings and options are accessed using the **MENU** button

Navigate using the **▲ ▼ ◀ ▶** and **OK** buttons

Exit sub-menus using **MENU**

Exit completely using **Cancel/Exit**

Picture Menu



Picture Mode: Standard, Mild, Personal, Dynamic

Brightness: Adjust picture brightness

Contrast: Adjust picture contrast

Sharpness: Adjust edge definition

Saturation: Adjust picture colour depth

Hue (NTSC only): Adjust picture hue

Color Temp: Standard, Cool, Warm

Aspect Ratio: Full, Zoom1, Zoom2, 4:3

Advanced Settings:

NR: Set noise reduction: Off, Weak, Medium, Strong

MPEG NR: Set MPEG noise reduction: Off, Weak, Medium, Strong

Dynamic Contrast: Automatically adjust picture detail and brightness: Off, Weak, Medium, Strong

Sound Menu

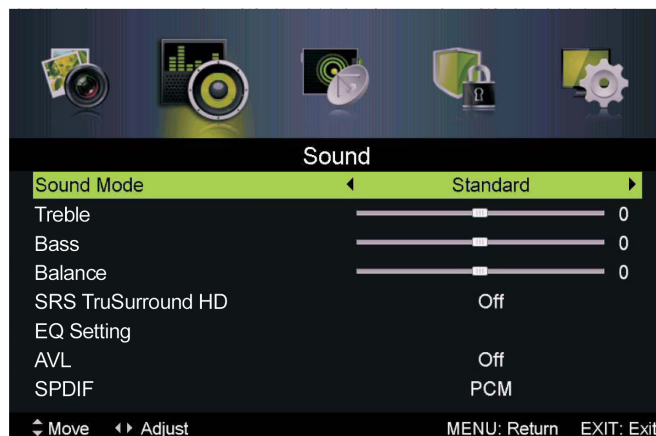

Sound Mode: Standard, Music, Personal, Movie

Treble: Adjust higher frequency audio

Bass: Adjust lower frequency audio

Balance: Adjust level between left and right speakers

SRS TruSurround HD: Surround sound effect: On or Off (switch Off to adjust EQ settings)

EQ Setting: 7-band graphic equaliser with presets: Off, Rock, Pop, Jazz, User

AVL: Automatic volume limiting: On or Off

SPDIF: Digital audio output: Off, Auto, PCM

Audio Description:

Mode: On or Off

Volume: Adjust AD volume separately

Sound Type: For use in dual language broadcasts: Stereo, Dual I, Dual II, Mixed

PLEASE NOTE

SRS TruSurround HD must be switched off to change Sound Mode and EQ settings.

Adjusting any picture or sound settings will automatically change the mode to *Personal*.

If you wish to reset all picture and sound adjustments: MENU > Setup > Reset

Channel Menu

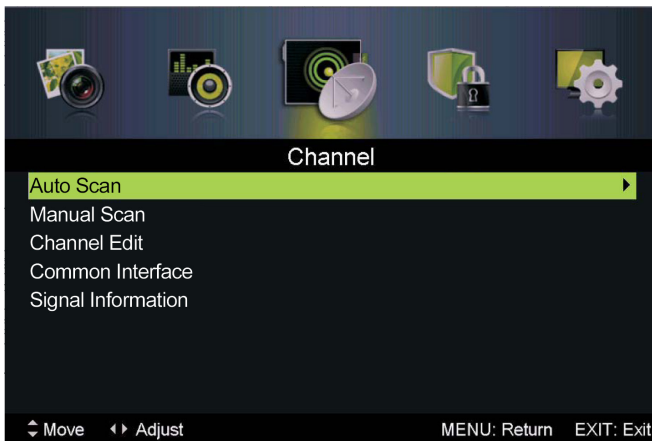

Auto Scan



Country: Choose country of installation: UK, Denmark, Finland, France, Germany, Hungary, Italy, Netherlands, Norway, Poland, Portugal, Russia, Serbia, Spain, Sweden

Mode: DTV, ATV, DTV+ATV

Start: Press ► or **OK** to start tuning scan

Manual Scan

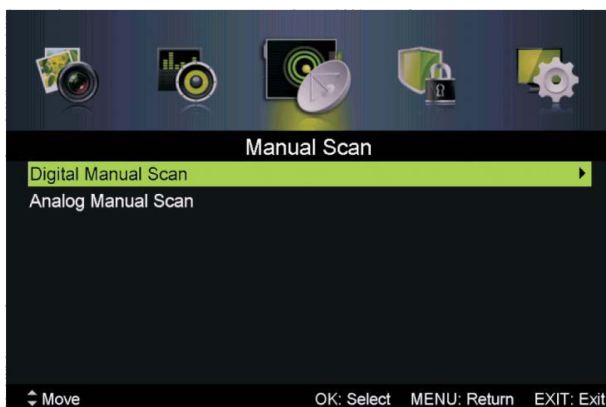

Digital Manual Scan

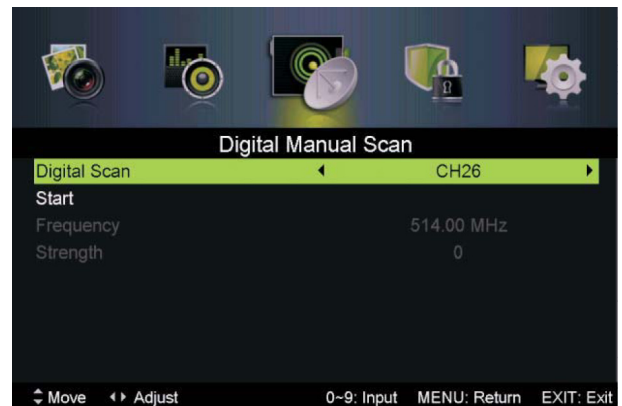

Digital Scan: CH- : Press ◀▶ to adjust channel

Start: Press ► or **OK** to start tuning scan

Frequency: Channel frequency in MHz (information only)

Signal: Signal strength for selected channel (information only)

Analog Manual Scan

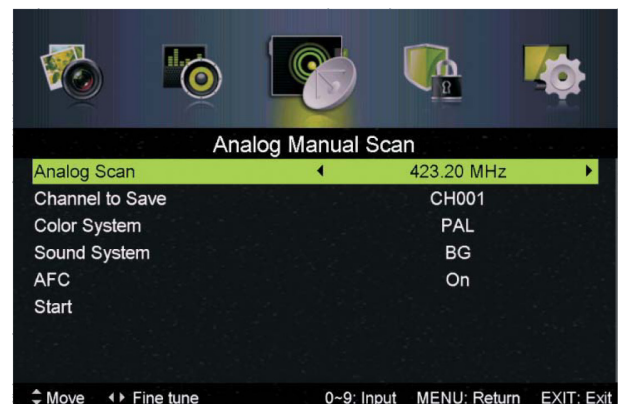

Analog Scan: - -MHz : Press ◀▶ to adjust frequency

Channel to Save: Press ◀▶ to adjust channel number to save to

Color System: Press ◀▶ to adjust: Auto, PAL, SECAM

Sound System: Press ◀▶ to adjust: Auto, DK, BG, I or L

AFC: Auto-Frequency Control: Press ◀▶ to adjust: On or Off

Start: Press ► or **OK** to start tuning scan

Basic Features

Channel Edit



Move and delete installed channels.

Highlight channel to edit, then press:

- RED:** Delete selected channel
- GREEN:** Skip selected channel (channel will be skipped when using CH+/CH-)
- BLUE:** Move selected channel (press **BLUE** once to “pick up” then press **BLUE** again when moved to required position)

To re-install a deleted channel, or to reset all channel positions: MENU > Setup > First Time Setup

Common Interface

Only available when CAM module inserted.

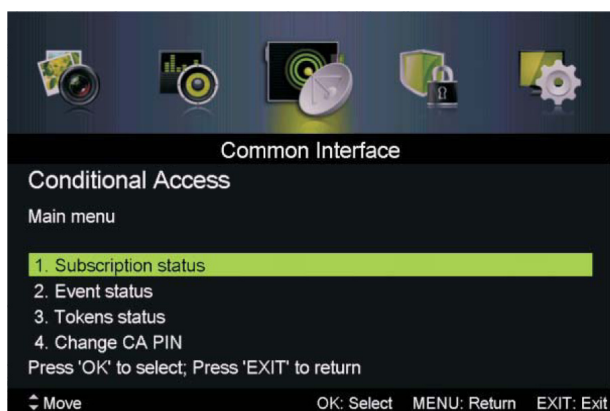

Display details of CAM module and card inserted.

CAM module and card available from subscription service provider

Signal Information



Displays signal details for DTV channels, for information only.

Lock System Menu



Allows password control of channel access and tuning functions.

Enter password to access (default 0000)



Channel Locks: Lock specific channels: In menu, select channel and press **OK** to lock.

Parental Rating: Lock adult channels (if channel supports)

Lock Keypad: Lock TV control buttons (remote functions not affected)

New Password: Change password

Clear Lock: Remove any set locks

PLEASE NOTE: Enabling the lock system locks all tuning options (Auto Scan, Manual Scan, First Time Setup)

When changing the password please remember to note the new password. If password lost see troubleshooting.

Basic Features

Setup Menu



OSD Language: Press ◀▶ to adjust: Choose on-screen display language: English, German, French, Italian, Spanish, Dutch, Portuguese

Audio Languages: Press ◀▶ to adjust: Choose primary and secondary audio language (programme dependent)

Subtitle

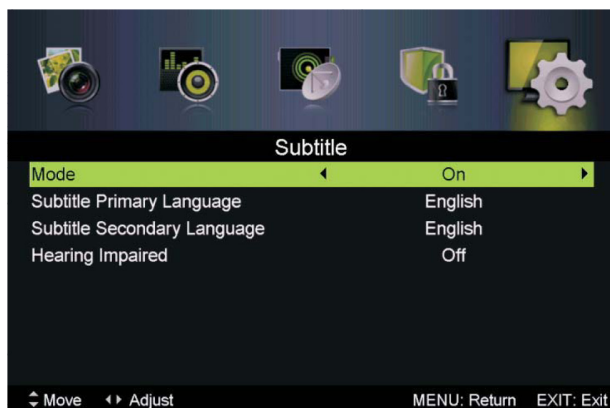

Mode: Press ◀▶ to adjust: On or Off
Subtitle Primary Language (programme dependent): Press ◀▶ to adjust
Subtitle Secondary Language (programme dependent): Press ◀▶ to adjust
Hearing Impaired: Press ◀▶ to adjust: On or Off

Teletext



Digital Teletext Language (programme dependent): Press ◀▶ to adjust
Decoding Page Language (programme dependent): Press ◀▶ to adjust

Mode Setting

Adjusts backlight brightness to suit different environments. Press ◀▶ to adjust.

Home Mode: Standard brightness, recommended for general home use.

Please select [Store mode] for store demo, press OK to proceed, other keys to cancel.

Store Mode: Full brightness, recommended for shop display use or very bright environments, this mode greatly increases power consumption.

Time Settings



OSD Time: Press ◀▶ to adjust: Off, 10, 20, 30, 60 seconds

Sleep Timer: Press ◀▶ to adjust: Off, 5, 15, 30, 60, 90, 120, 240 minutes

Auto Sleep: Press ◀▶ to adjust: Off, 3, 4, 5 hours

Time Zone: Press ▶ to enter, ▲▼ to adjust

Time: Press ▶ to enter, ▲▼◀▶ to adjust

Auto Sync: Set time via DTV signal: On or Off

Date: Current date

Time: Current time

Time zone, date and time settings will be set automatically when tuned in to a digital TV signal.

First Time Setup

Reset and delete all stored channels and menu options.

Press ▶ or **OK** to enter, follow the guide on Page 12 to complete.

This reset method is recommended when retuning messages are received from broadcasters.

PLEASE NOTE: All stored preferences are deleted during First Time Setup, including any favourite lists or password locks.

Reset

To reset all menu options, such as picture and sound settings. Tuning data is retained.

Press ▶ or **OK** to enter

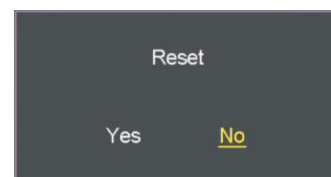

Press ◀ to select Yes, press **OK** to confirm

Advanced Features

Electronic Programme Guide (EPG)



To access your 7-day electronic programme guide press the **EPG** button.

The EPG shows TV and radio programme times and details up to 7 days ahead and also allows programme reminders to be set.

Navigate using the **▲▼◀▶** and **OK** buttons

◀▶ will move between channel and programme

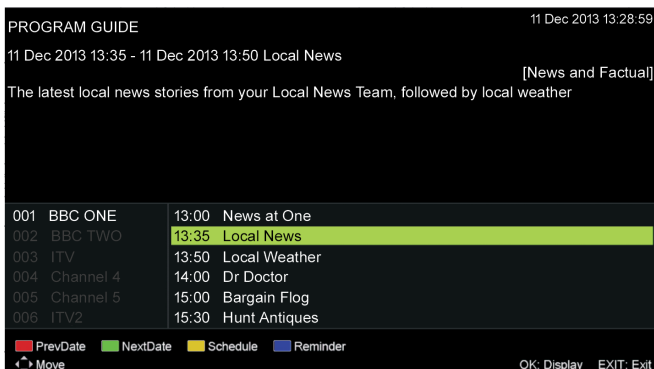

▲▼ will move up and down channels and programmes

- RED:** Move back in time (to present)
- GREEN:** Move forward in time (up to 7 days)
- YELLOW:** Display reminder schedule
- BLUE:** Set programme reminder

Reminder

Frequency: Press **◀▶** to adjust: Off, Once, Daily, Weekly

Channel: Press **◀▶** to adjust

Start Time: Press **▶** to enter

Save: Press **OK** to save reminder

Digital Teletext

Digital teletext is available on certain channels or broadcasts.

To access press **TXT**, navigate using the **▲▼◀▶** and **OK** buttons

To access BBC Red Button services, such as interactive broadcasts, press the **RED** button

To exit press the **TXT** button



Not all channels provide digital teletext, services are broadcast dependent.

Digital Radio

Digital radio stations are available by pressing the **DTV/Radio** button, or by scrolling through the programme list.

Radio functions are the same as for TV

Use the EPG or Channel List to browse available stations or set reminders.

Common Interface (CI)

The Common Interface (CI) slot enables access to additional Freeview subscription services.

In order to receive subscription channels a Conditional Access Module (CAM) and subscription viewing card is required.

- Before inserting CAM disconnect TV from mains supply.
- Insert the viewing card into CAM
- Insert the CAM into TV, firmly but gently.
- Switch TV back on
- Check CAM and card are installed, see Page 16

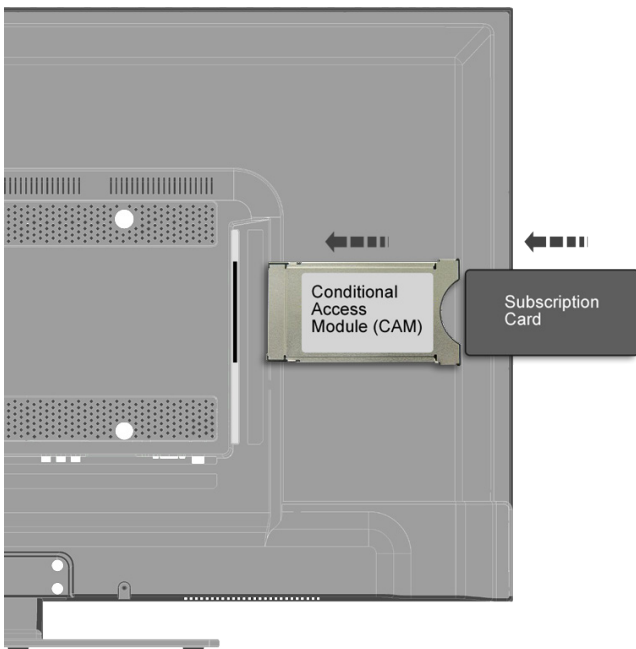

For any questions or issues with subscription services please contact your service provider.

Channel List

To display a list of all available channels press **OK** or **List**

Navigate using the **▲ ▼ ◀ ▶** buttons and press **OK** to select

Favorite List

Create a list of your favourite channels for quick access.

To display and add favourite channels press **FAV**.



To add a favourite channel, select the appropriate channel press **FAV** then **GREEN** button.

To delete a channel from the favourite list press **FAV**, select the appropriate channel then **RED** button.

Advanced Features

On-Screen Displays

No Signal

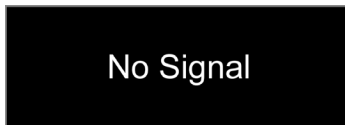

This will be displayed if the TV is not detecting a signal on the input selected.

If displayed please check correct source is selected and any cables are fully inserted.

INFO - Now & Next

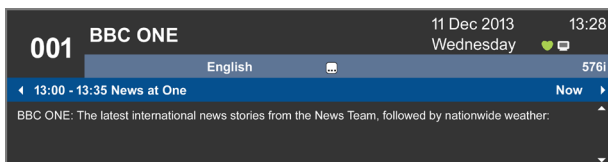

To display the current programme information press **INFO**

To display information for next programme press **INFO** then **▶**

Connecting to a PC

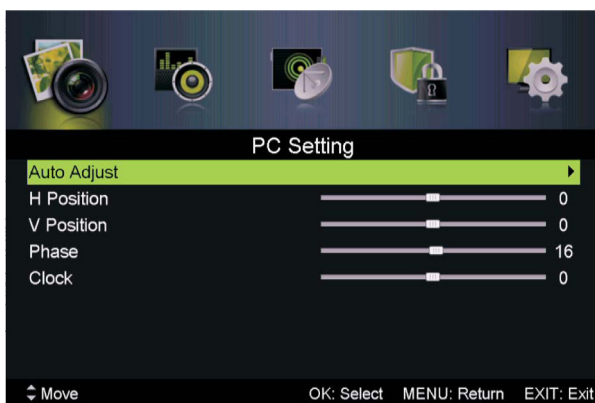

Connect to a PC via VGA, picture settings will differ.

Auto Adjust: Press **▶** to confirm

H Position: Press **◀▶** to adjust horizontal position

V Position: Press **◀▶** to adjust vertical position

Phase: Press **◀▶** to adjust phase

Clock: Press **◀▶** to adjust clock rate

Changing input source

To switch between the available inputs press **SOURCE**

Navigate using the **▲▼** buttons and press **OK** to select

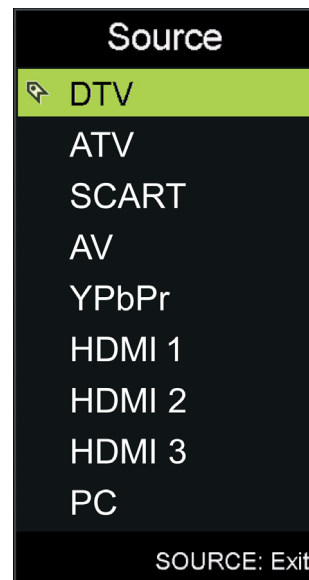

Select AV source for composite VIDEO, L, R input

Fitting the base stand

To minimise packaging the stand is packed separately as two parts.

Before you begin, check all the stand parts are included:

- 1 x Stand base
- 1 x Stand stem
- 4 x Base screws (short)
- 4 x Stem screws (long)

- Place TV, screen down, on a suitable scratch-free surface.
- Insert the base stem into base of cabinet and secure using supplied screws (x 4)
- Locate the base onto the 4 screw mounts.
- Once in position use the supplied screws (x 4) to secure.

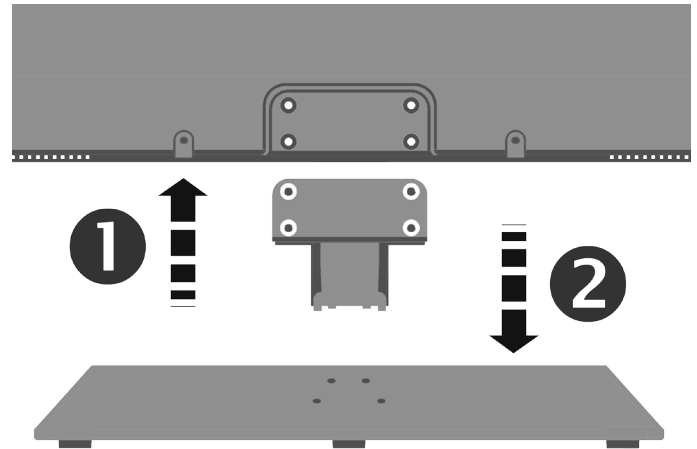

Wall Mounting

Requires VESA 200 x 200mm mounting kit with M6 bolts (not supplied)

- Place TV, screen down, on a suitable scratch-free surface
- Remove screws (x 4) at top of base stem and carefully remove stand
- Locate the mounting holes on rear of TV and fit bracket according to manufacturer's instructions

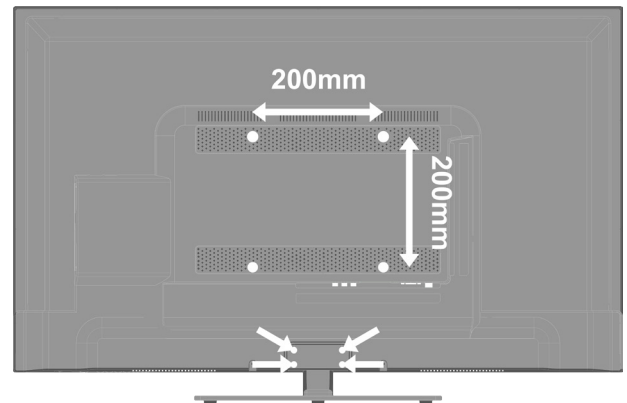

Argos Ltd. accepts no responsibility for any damage caused to, or by, incorrect mounting of the wall bracket.
Pay close attention to the manufacturer's instructions.

Troubleshooting

Should you experience difficulties operating this product please consult the suggestions below before contacting the Customer Helpline.

	Symptom	Possible cause	Solution
TV	Dead. No signs of power	Power not connected to device	Check mains power connection, especially if using a power extension
		Fuse failure	Replace 5A fuse in mains plug
	No picture. LED lit RED	TV in standby	Try POWER button on TV
		Software error	Disconnect TV from mains supply for 60secs, then reconnect and try again
	No picture or OSD on any source, sound audible. LED lit GREEN	Backlight	Contact customer helpline: 0845 604 0105
	Picture but no sound	Headphones inserted	Disconnect any connections to headphone socket
		Connection problem	Check other sources or DVD
	No Signal displayed	Incorrect source selected	Press SOURCE , select correct input, press OK
		DTV: TV not tuned in	Try First Time Setup on Page 19
		DTV: Aerial not connected or not suitable	Connect a suitable aerial
	TV channels missing	Poor aerial signal	Check aerial signal, if possible try on another aerial point
TV picture and sound breaking up and freezing	Poor aerial signal	Check aerial signal, if possible try on another aerial point	
Red, green, blue or black dots on screen	Stuck pixel	Try gently rubbing pixel affected with a soft cloth, if persists contact customer helpline for further advice: 0845 604 0105	
Remote control	Intermittent operations	Loose battery	Check battery connections
	No remote functions	Batteries exhausted	Replace batteries
	Lost password	Child lock	4711

Specifications

Power requirements	110-240V AC ~50/60Hz 44W Average (70W Max)	
Standby power	<0.3W	
RF Input	75Ω (unbalanced)	
Speakers	2 x 10W	
Analogue systems	PAL, SECAM (BG, DK, I, L)	
Digital system	DVB-T CH21-CH69	
OSD languages	English, German, French, Italian, Spanish, Dutch, Portuguese	
Country of origin	China	
Dimensions (mm)	with stand	934 x 604 x 209
	without stand	934 x 561 x 88
Weight (kg)	with stand	9.47
	without stand	8.22
Wall mounting	VESA 200 x 200mm (M6 x 10mm bolts)	
Remote control batteries	AAA x 2	

Technical specifications are subject to change without notice. Errors and omissions are exempted

v.180114

SRS  is a trademark of SRS Labs, Inc.
TruSurround HD

TruSurround HD technology is incorporated under license from SRS Labs, Inc.



Product Guarantee

This product is guaranteed against manufacturing defects for a period of



This product is guaranteed for twelve months from the date of original purchase. Any defect that arises due to faulty materials or workmanship will either be replaced, refunded or repaired free of charge where possible during this period by the dealer from whom you purchased the unit.

The guarantee is subject to the following provisions:

- The guarantee does not cover accidental damage, misuse, cabinet parts, knobs or consumable items.
- The product must be correctly installed and operated in accordance with the instructions contained in this manual.
- It must be used solely for domestic purpose.
- The guarantee will be rendered invalid if the product is re-sold or has been damaged by inexpert repair.
- Specifications are subject to change without notice.
- The manufacturer disclaims any liability for the incidental or consequential damages.
- The guarantee is in addition to, and does not diminish your statutory or legal rights.
- In the event of a problem with the product within the guarantee period call the **Customer Helpline: 0845 604 0105**.

Guarantor: Argos Ltd
489 - 499 Avebury Boulevard
Central Milton Keynes
MK9 2NW

The Argos Technical Helpline is here to help

Technical experts are available 7 days a week

- **Simple help and advice on setting up your digital equipment.**
- **Guidance on connecting other devices to your television such as DVD player, Sky, home cinema system or a games console.**
- **Order spare parts, including that lost remote control.**
- **Any other technical issues you may need assistance with.**

Call us today: 0845 604 0105

Local call rate applies*

Lines open 9am-8pm Monday to Saturday and 10am-4pm Sunday.

*Calls to Argos enquiry lines may attract a charge and set up fee from residential lines depending on your call plan/tariff. Mobile and other providers costs may vary, see www.bt.com/pricing for details.

For security and training purposes, telephone calls to and from customer service centres may be recorded and monitored. Calls from Republic of Ireland will attract international call charges.